



## **XF1000V2 OPERATION MANUAL**

High Brightness 10.4 inch Vehicle Monitor

---

## Safety precautions

In this manual, symbols are used to highlight warnings and cautions for you to read so that accidents can be prevented. The meanings of these symbols are as follows:

This symbol indicates explanations about extremely dangerous matters. If users ignore this symbol and handle the device the wrong way, serious injury or death could result.



This symbol indicates explanations about dangerous matters. If users ignore this symbol and handle the device the wrong way, bodily injury and damage to the equipment could result.



Please observe the following safety tips and precautions to ensure hazard-free use of the equipment.

### Disclaimer

We shall not be liable for any error or for incidental or consequential damages in connection with the furnishing, performance, or use of this documentation or the examples herein.



1. This equipment should not be submerged on water or other liquids.



2. Do not cover crash or press the display area.



3. Do not attempt to remove the cover of this equipment. Any visible attempting of removing will exempt any manufacturer responsibility.



4. If any of the following situations arises, have the equipment checked by an authorized service personnel:

Any connector is damaged.  
The cable/cord is damaged.  
The equipment has obvious sign of breakage.



### Environment

To prevent the risk of fire, electric shock or malfunction, avoid using your equipment in environments where it will be exposed to:

- Extreme temperatures, over the operation range.
- Heat sources such as radiators or stoves.
- High humidity or moisture.
- Excessive dust or sand.



### Handling

• Do not place naked flame sources, such as lighted candles, on the device.



• Do not exert undue pressure on the keys and other controls. Also take care not to drop the unit, and do not subject it to shock or excessive pressure.

• Don't overpress the LCD or touch panel, it would damage one or either components.

### Cleaning



Use a soft, dry cloth to clean the chassis and LCD/Touch surface. If necessary, slightly moisten the cloth. Adequate LCD liquid cleaner might be used to remove dust and finger prints.

### Connection



Voltage values measured using 10 cm all in one testing cable. Don't connect the unit to over the maximum voltage ratings, it will damage the unit and harm to the user.

The device is fully protected and ready to be connected to 9-24V DC power.

### Security usage

Don't operate the device while driving. In several countries, it's forbidden to operate any visual device, either forbidden to visualize any content except GPS or similar guidance utility. The manufacturer isn't responsible or any harm caused by the unsecure use of our devices while driving.

Please keep this manual in a convenient place for future reference.

## Contents

1 .....	Introduction .....	Page 1
2 .....	Specification .....	Page 1
3 .....	Installation .....	Page 2
	3.1 Connection .....	Page 2
	3.2 Power on .....	Page 4
4 .....	Adjusting .....	Page 4
	4.1 Keyboard .....	Page 4
	4.2 OSD(On Screen Display) .....	Page 5
	4.3 Basic settings .....	Page 6
	4.4 Advanced Settings .....	Page 7
5 .....	Dimensions .....	Page 8
6 .....	Packing .....	Page 9
7 .....	Certifications .....	Page 10
8 .....	Sunlight Readable display.....	Page 11

---

## 1. Introduction

The XF series provides the best interactive HMI solution for any embedded application. The XF series is specially designed to meet harsh environment such as sustaining extreme shock and vibration. By introducing some key features, such as using “all in one” lockable cable, and simple OSD interface for easy and convenience usage, including a dimmer shortcut key and autodimmer features.

## 2. Specifications

Size	10.4 inches
Aspect	4:3
Colors	256k
Native resolution	1024 x 768px
VGA modes	VESA standard 640x480 to 1920x1440px
Contrast	500:1
Inputs	VGA/DVI/HDMI(factory option) ,2x Composite Video.
Audio	2 x 1.8W (stereo). Optional.
Touch Panel	Resistive 4 wires. Endurance >2M touch. PCT multi-Touch optional.
Power supply	9-36VDC automotive car/truck suitable.
Power consumption	N*:7W. HB:11W SHB: 13W
Dimensions	247.5 x 184.3 x 31mm
Weight	1000gr
Enclosure	Aluminum chassis/rear. PVC-ABS front.
Operation temperature.	
Resistive:	-30°C to 70°C (-20°C to 60°C continuous)
Capacitive:	-30°C to 75°C
Storage temperature:	-40°C to 85°C
Vibrations	1G 2-500Hz
Shock	20G 11ms
Drop	10cm max.

### 3. Installation

#### 3.1 Connection.



**Power supply:** main power supply. Connect this line to 2-3A fused vehicle's power battery.

**VGA input:** computer or any device with VGA input.

**USB Touch:** touch controller HMI USB client.

**Audio input R:** Audio input Right channel.

**Audio input L:** Audio input Left channel.

**Video input AV1:** Composite Video input 1.

**CCD Input:** Composite Video input with\*auto-switch and \* auto-start feature.

**Auto-switch:** the monitor will automatically switch to the CCD input when composite Video signal is present on CCD input. The monitor will return to the previous input once the signal isn't present.

**Auto-start:** the monitor will automatically power on and switch to CCD input when signal is present. The monitor will turn to power-off automatically when the signal isn't present.

Typical connection:

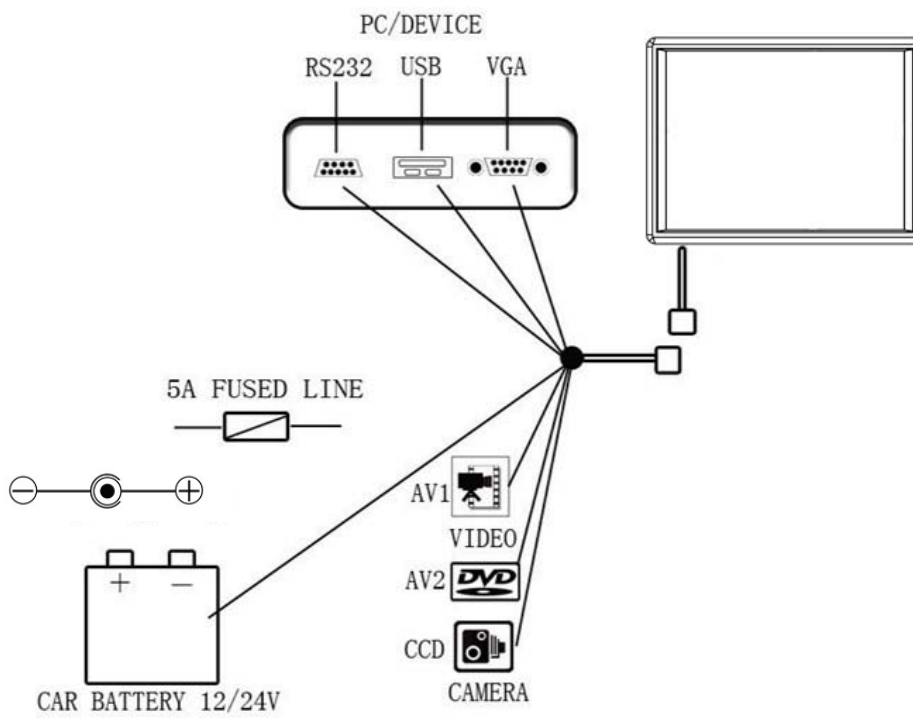

### 3.2 Power on.

Please verify the polarity of the power supply and connections before power on the unit. After connect the power supply, there are different ways to power on the monitor:

1. Connect the VGA to any VGA source.
2. Connect the Rear camera input to a CVBS source.
3. Press the power on button , the power indicator will turn on.
4. The monitor will turn on and autoadjust and autocenter the screen. If the image isn't centered, proceed with autoconfig or manual adjustment.

## 4. Adjusting







### 4.1 Keypad.



1. Power On.
2. Power on Indicator / LED.
3. Show OSD Menu / exit OSD.
4. Decrease Volume/OSD Parameter .
5. Source switching.
6. Increase Volume/OSD Parameter .
7. Dimmer

4.2 OSD (On Screen Display).





		Function		
	Name	Powered off	Powered on Shortcut	Powered on Menu opened
	Dimmer		Short press: Dimmer Level 2s Press: switch to Auto-Dimmer	Roll parameter
	Dec		Volume Dec	Dec Value
	OK	Power on and roll source	Roll Source	-
	Inc		Volume Inc	Inc Value / Accept
	Menu		Open OSD	Return / Close Menu
	Power	Power on	Power Off	Power Off







### 4.3. Basic Settings

#### Color

	Brightness	<input type="range" value="80"/>	80
	Contrast	<input type="range" value="50"/>	50
	Color Temp		6500K





1024X768 60HZ

#### Adjust

	Auto Config		
	H Position	<input type="range" value="50"/>	50
	V Position	<input type="range" value="50"/>	50
	Phase	<input type="range" value="4"/>	4
	Clock	<input type="range" value="50"/>	50





1024X768 60HZ

#### OSD

	Language		English
	H Position	<input type="range" value="50"/>	50
	V Position	<input type="range" value="50"/>	50
	OSD Timeout		10
	Transparent		Off

1024X768 60HZ

#### Function

	Dimmer mode		Manual
	Time constant		2
	Threshold1		12
	Threshold2		19
	Threshold3		22

1024X768 60HZ

#### Sound

	Volume	<input type="range" value="50"/>	50
---	--------	----------------------------------	----

1024X768 60HZ





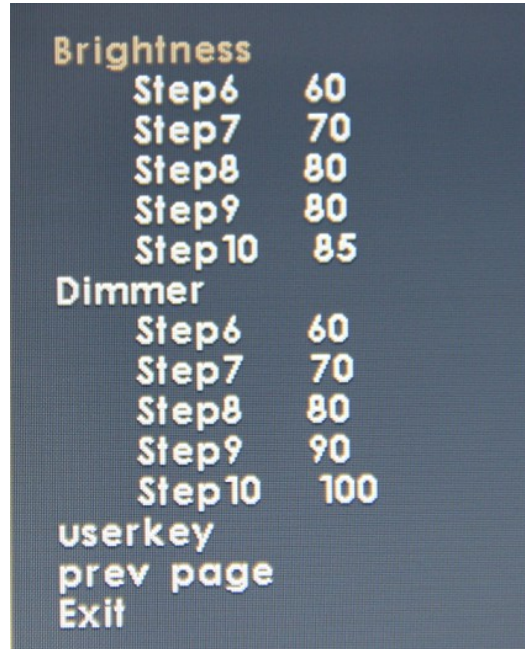
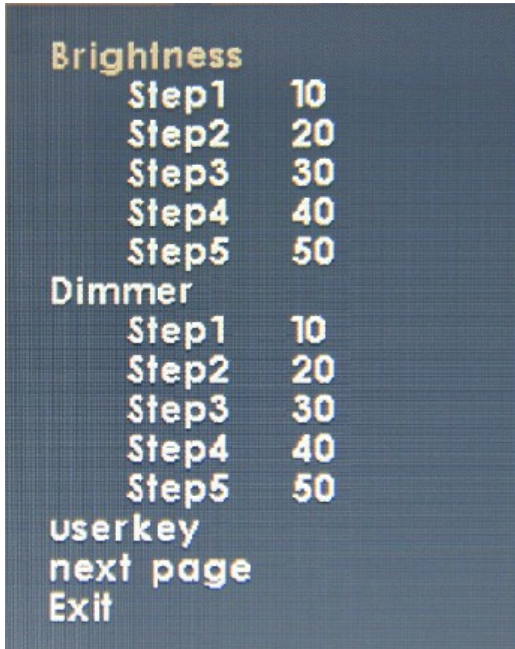

#### 4.4. Advanced Settings.

To enter in advanced mode, press  and  simultaneously.

##### 4.4.1. Dimmer options.



The dimmer option allows to configure the values of brightness and backlight intensity for each step:

1. Use  to select the desired parameter.
2. Use  to enter in edit mode.
3. Use  and  to adjust from 0 to 100.
4. To exit, roll to Exit using  and press , the settings are automatically stored.

## 5. Dimensions

### 5.1 Front/profile.

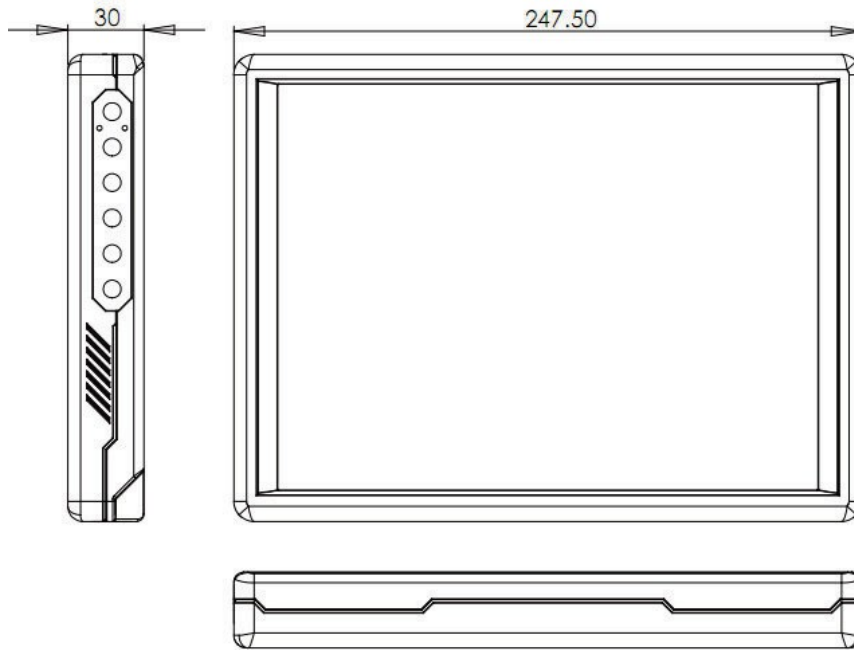

### 5.2 Rear

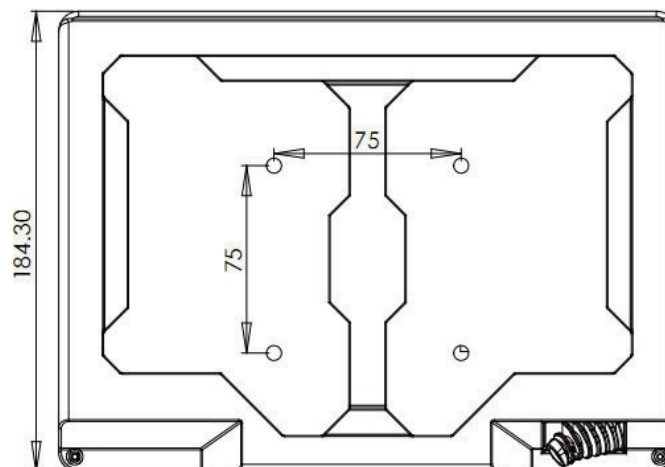

## 6. Packing

### 6.1 Box unpacking

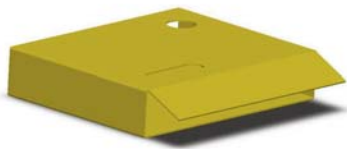
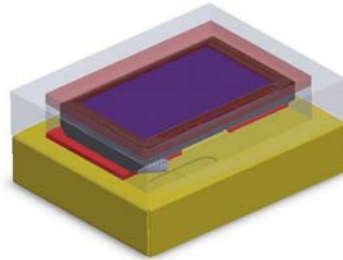

Accessories

### 6.2 Carton packing



BOX SIZE: 33x25.5x10cm

Q'TY/CTN: 1 UNITS

GW/CTN(kgs): 1.98Kg(2.5-meter-cable)

2.14Kg (4.5-meter-cable)

NW/CTN(kgs): 1.38Kg (2.5-meter-cable)

1.54Kg ( 4.5-meter-cable)

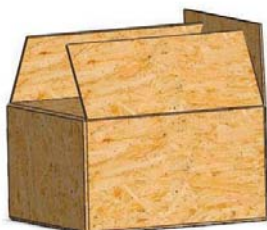

CTN SIZE: 53x53x34cm

Q'TY/CTN: 10 UNITS

GW/CTN(kgs):21.5Kg(2.5-meter-cable)

23.1Kg(4.5-meter-cable)

NW/CTN(kgs): 19.8Kg (2.5-meter-cable)

21.4Kg (4.5-meter-cable)



15" Touch Screen Display, Resolution: 1024x768 px.

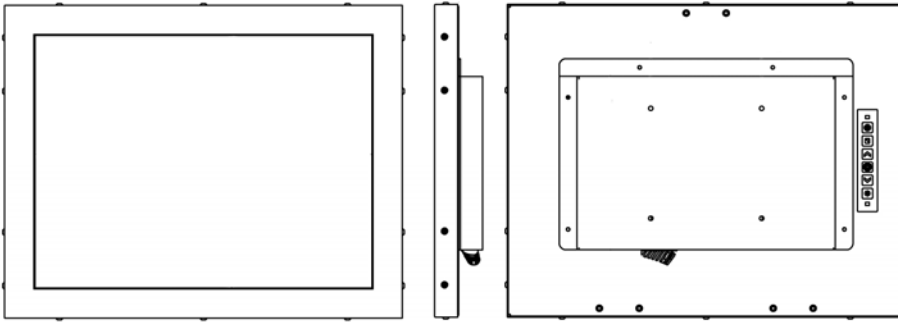

19" Touch Screen Display, Resolution: 1280x1024 px.

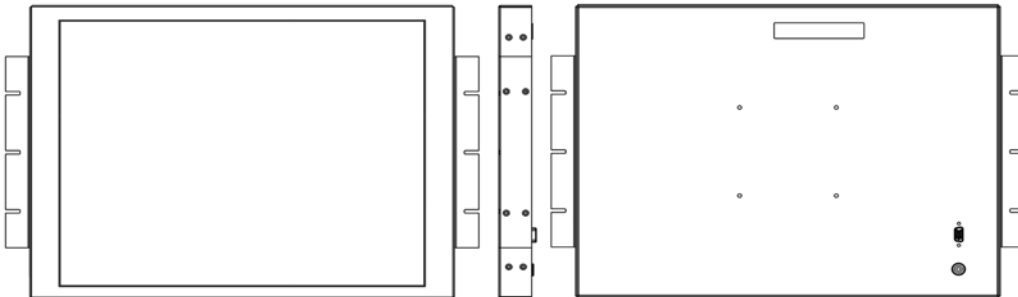

21.5" Touch Screen Display, Resolution: 1920x1080 px.(full HD).

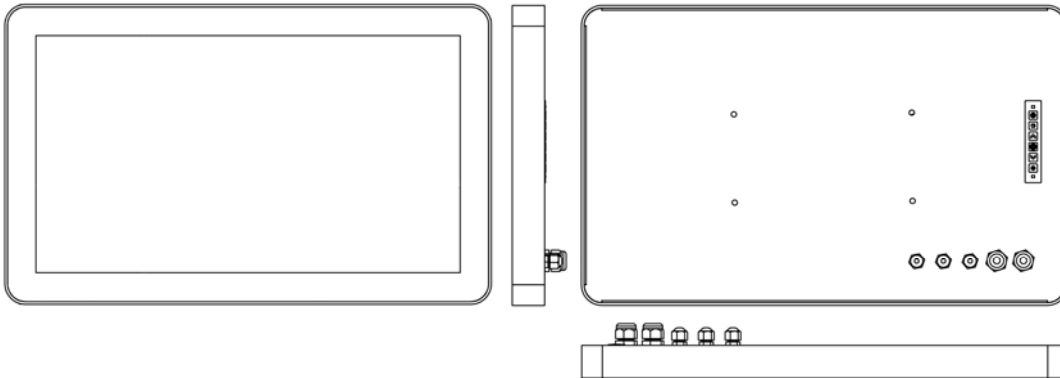

42" Touch Screen Display, Resolution: 1920x1080 px.(full HD).

